

K'NEX®

Building Worlds Kids Love®

**35 MODEL
ULTIMATE
BUILDING SET**

**35 MODÉLES
ULTIME
JEU DE CONSTRUCTION**



**35
BUILDING
IDEAS!
IDÉES DE
CONSTRUCTION !***

*Ideas de construcción
Bauvorschläge
Idee di costruzione
Ideias de construção
Bouwideeen

7+

12418

**AMERICA'S
BUILDING TOY™
JOUET DE CONSTRUCTION
d'AMERIQUE**

(EN) CONTENTS

Ice Cream Cone/Fish4	Tyrannosaurus.....10
Coconut Tree5	Ferris Wheel12
Plane6	Catamaran14
Skier7	Excavator.....17
Rocket Ship.....8	Building Ideas20

AMERICAN MADE PARTS

Parts List

Before you start building, be sure to compare the parts in your set with the parts list here. If anything is missing, call or write to us using the information on the back cover. We are here to help you!



K'NEX Building Basics

Start Building

To begin your model, find the 1 and follow the numbers. Each piece has its own shape and color. Just look at the pictures, find the pieces in your set that match and then connect them together. Try to face your model in the same direction as the instructions while you build. The arrows show you where the parts connect, but not all connections points have arrows. Faded colors show you this section is already built.

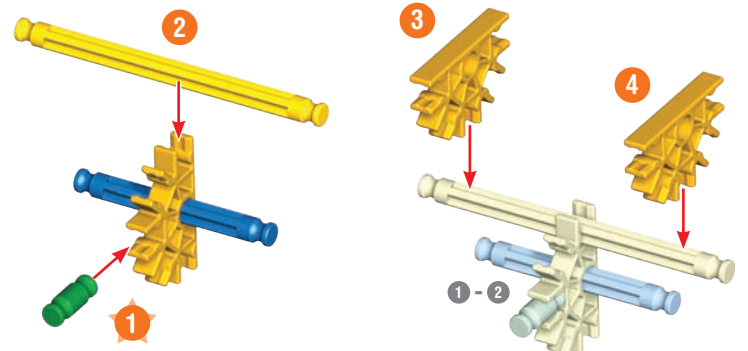

Spacers

There are places in your model where you need to use spacers. Be sure to use the correct number of spacers shown in the instructions.



Connectors

You can slide these special connectors together. Push tightly until you hear a "click". Pay close attention to the instructions and position them horizontally or vertically exactly as they are shown.

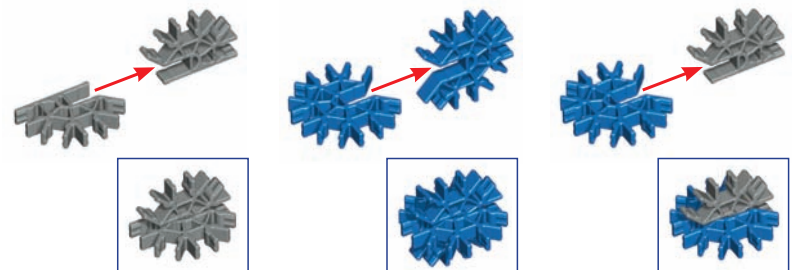

(FR) **CONTENUS**

Cornet de Crème Glacée/	Fusée	8
Poisson	Tyrannosaurus.....	10
Cocotier	Grande Roue.....	12
Avion.....	Catamaran	14
Skieur	Pelle	17
	Idées de construction...20	

FAIT AUX ÉTATS-UNIS

Liste des pièces

Avant de commencer, s'assurer de comparer les pièces dans la boîte à la liste de pièces fournie ici. S'il manque quelque chose, nous téléphoner ou nous écrire en vous servant des informations figurant au verso de la notice. Nous sommes là pour vous aider.



Esenciales de construcción K'NEX

Démarrer la construction

Pour commencer le modèle, trouver l'étape numéro 1 trouver les numéros. Chaque pièce a sa propre forme et sa propre couleur. Regarder les illustrations, trouve les pièces qui correspondent à l'illustration et les assembler. Pour vous faciliter la tâche, orienter le modèle dans le même sens que les instructions. Les flèches indiquent où les pièces s'assemblent, mais les points de raccordement n'ont pas tous des flèches. Les pièces de couleur délavées sont celles déjà assemblées.

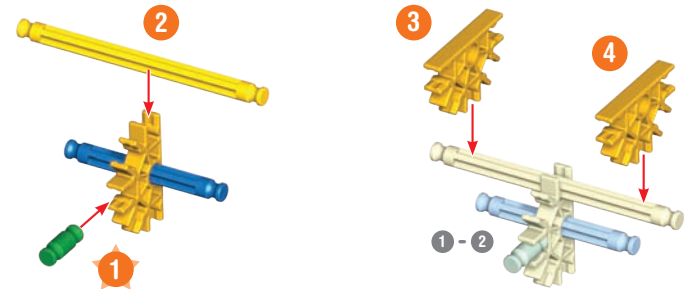

Espaceurs

Il y a des endroits sur le modèle où des espaceurs sont nécessaires. S'assurer d'utiliser la bonne couleur et le nombre d'espaceurs indiqué sur les instructions.



Connecteurs

Vous pouvez assembler ces connecteurs tout à fait uniques en les faisant glisser l'un dans l'autre. Pousser fort jusqu'au « clic ». Lire les instructions attentivement et les positionner horizontalement ou verticalement, en suivant exactement les illustrations.

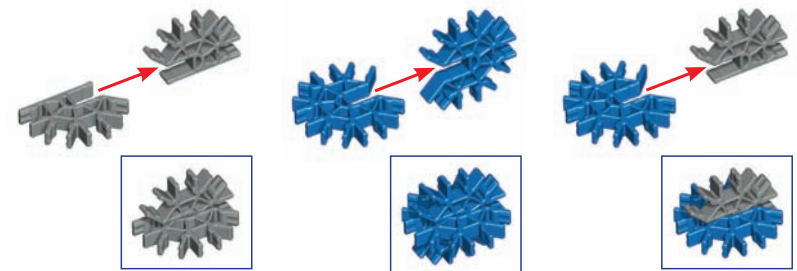

Ice Cream Cone Cornet de Crème Glacée

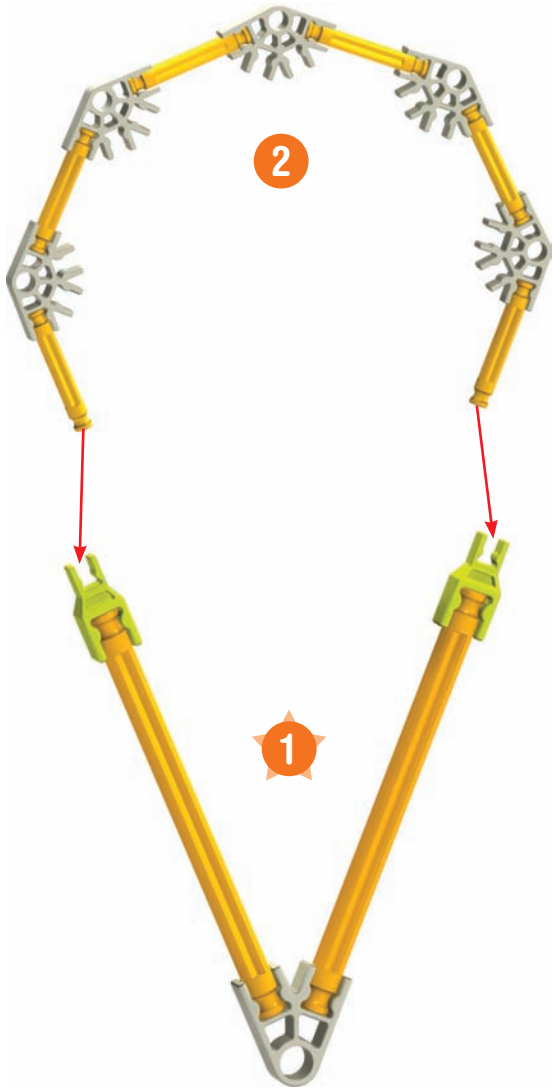

WARNING: CHOKING HAZARD – Small parts. Not for children under 3 years.

ATTENTION : RISQUE D'ÉTOUFFEMENT – Pièces de petite taille. Ne convient pas aux enfants de moins de 3 ans.

ADVERTENCIA: PELIGRO DE ASFIXIA – Piezas pequeñas. No para niños menores de 3 años.

WARNHINWEIS: ERSTICKUNGSGEFAHR – Kleinteile. Nicht geeignet für Kinder unter 3 Jahren.

AVVERTENZA: PERICOLO DI SOFFOCAMENTO – Contiene piccole parti. Non adatto per bambini al di sotto di 3 anni.

AVISO: PERIGO DE SUFOCAÇÃO – Peças pequenas. Não se destina a crianças com menos de 3 anos de idade.

WAARSCHUWING: VERSTIKKINGSGEVAAR – Kleine onderdelen. Niet geschikt voor kinderen onder 3.

CAUTION: Keep hands, face, hair and clothing away from all moving parts.

ATTENTION : Garde les cheveux, les doigts, la figure et les vêtements à l'écart de toutes les pièces mobiles.

PRECAUCIÓN: Mantén el cabello, los dedos, la cara y la ropa alejada de las piezas móviles.

VORSICHT: Haare, Finger, Gesicht und Kleidungsstücke nicht mit beweglichen Teilen in Berührung kommen lassen.

ATTENZIONE: Tenere i capelli, le dita, il viso e i vestiti lontano da tutte le parti in movimento.

CUIDADO: Mantém o cabelo, os dedos, a cara e a roupa afastados de todas as peças móveis.

OPGEPAST: Hou het haar, de vingers, het gezicht en kledij verwijderd van alle bewegende onderdelen.

Fish Poisson

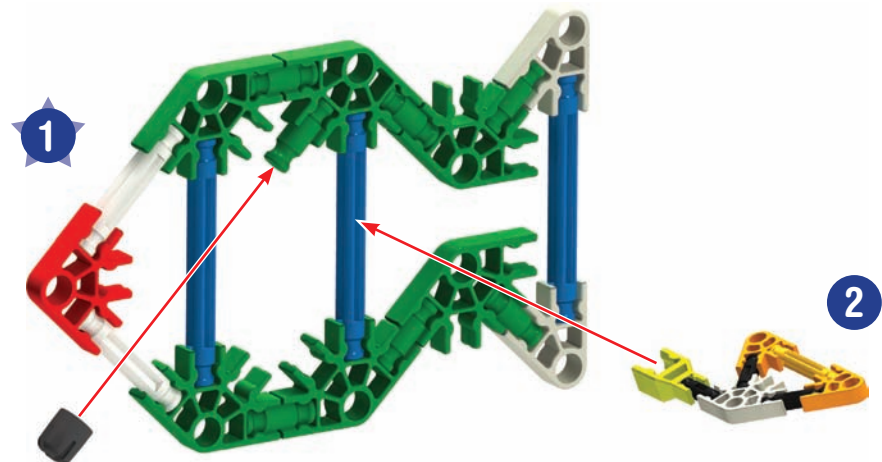
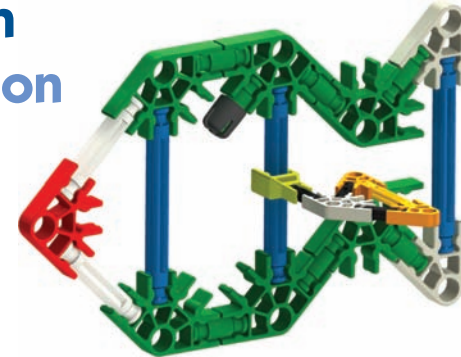

Coconut Tree Cocotier

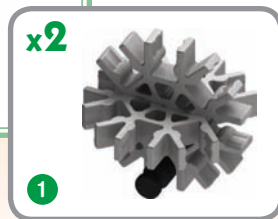
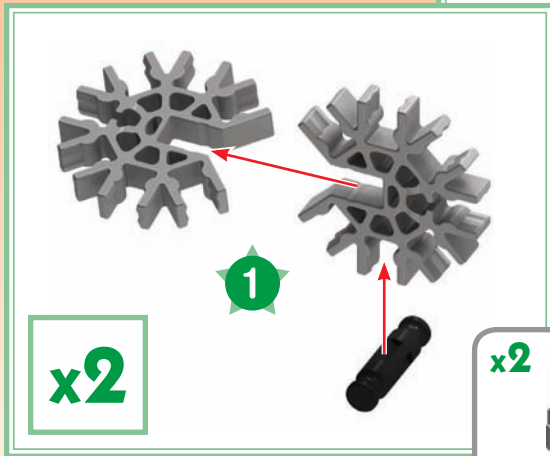
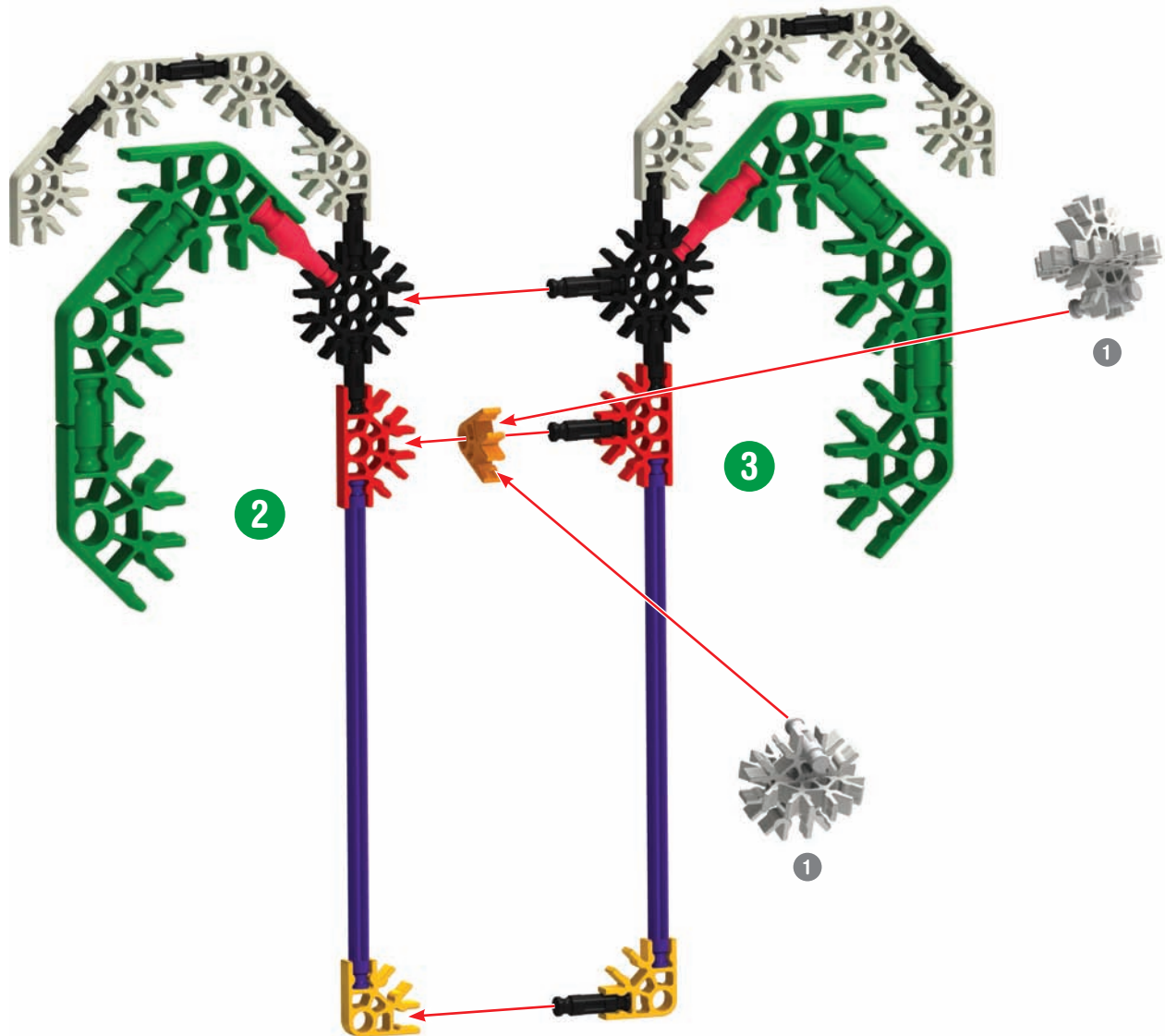
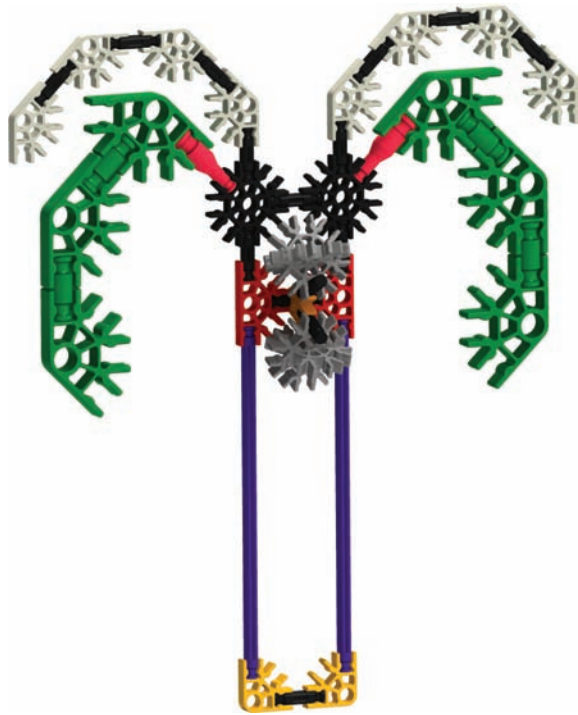

Plane Avion

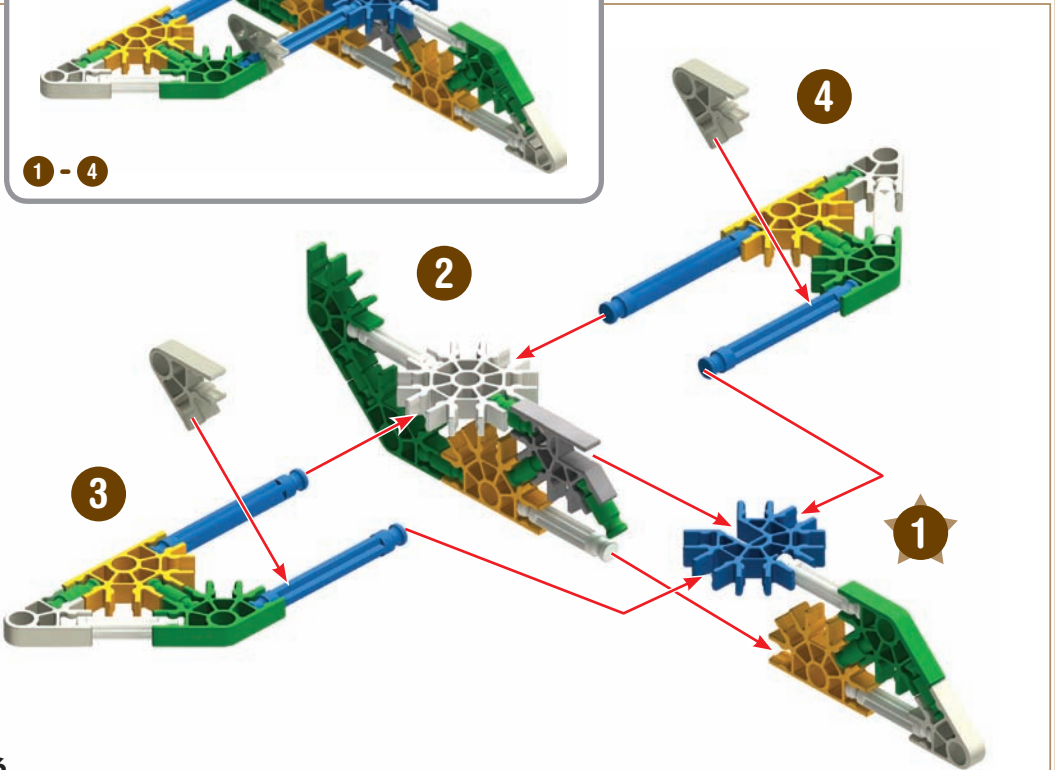
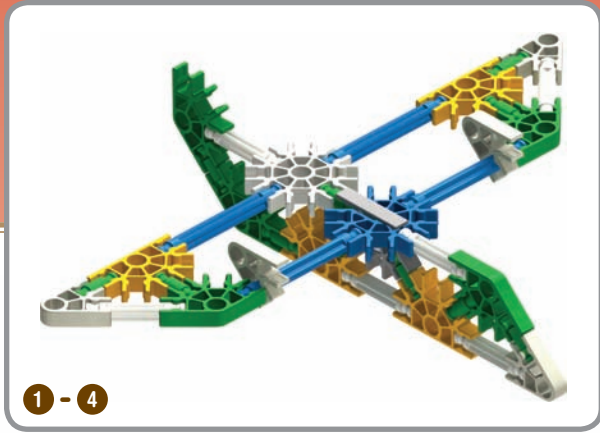
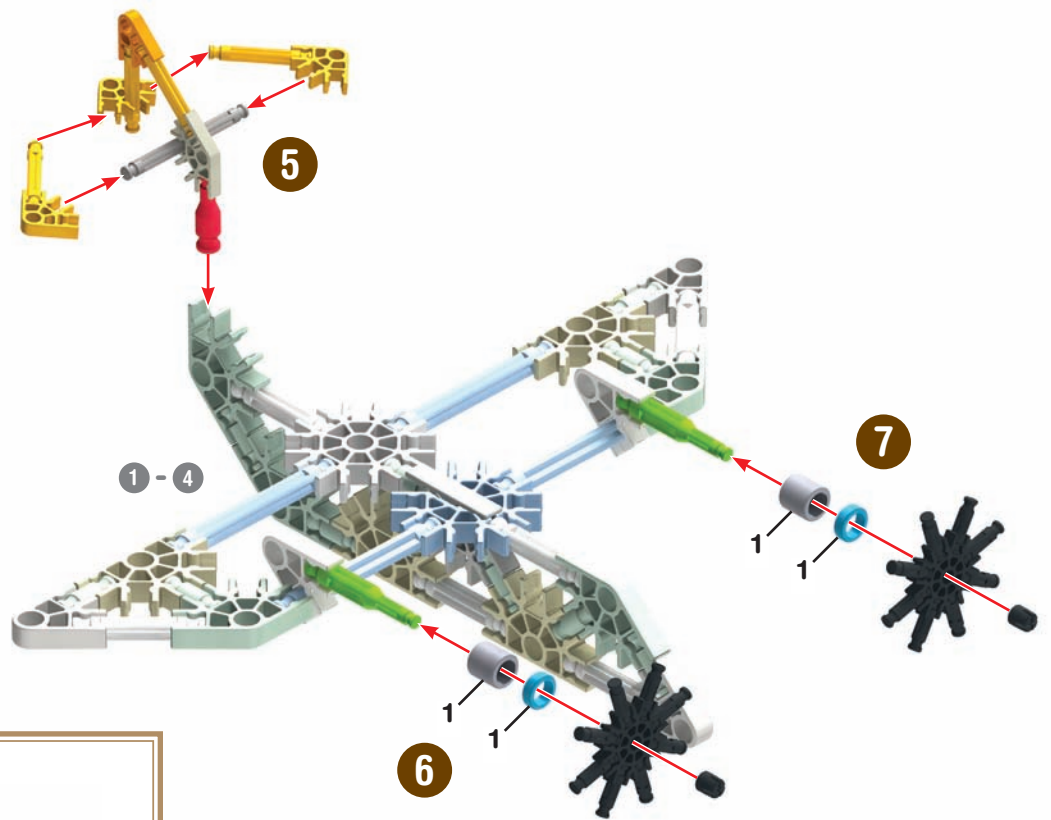

Skier Skieur

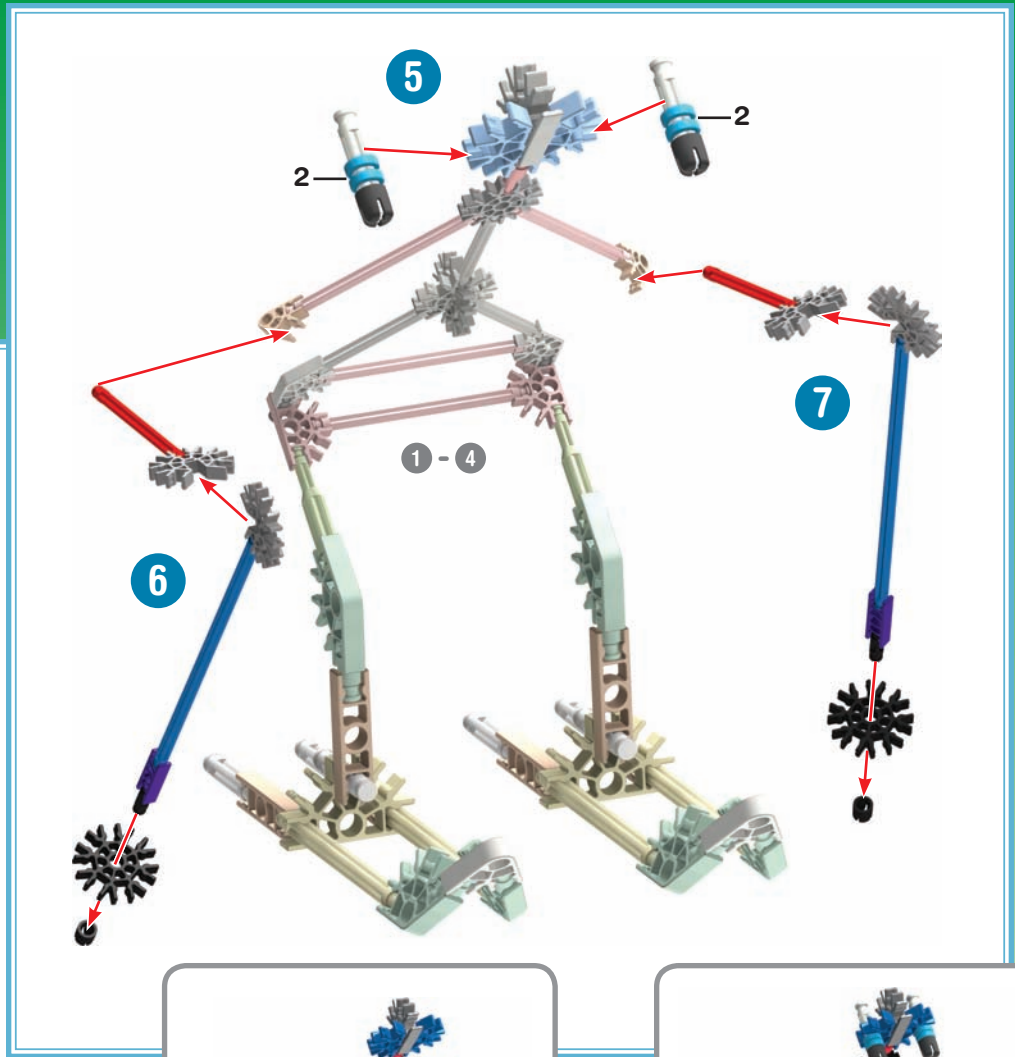
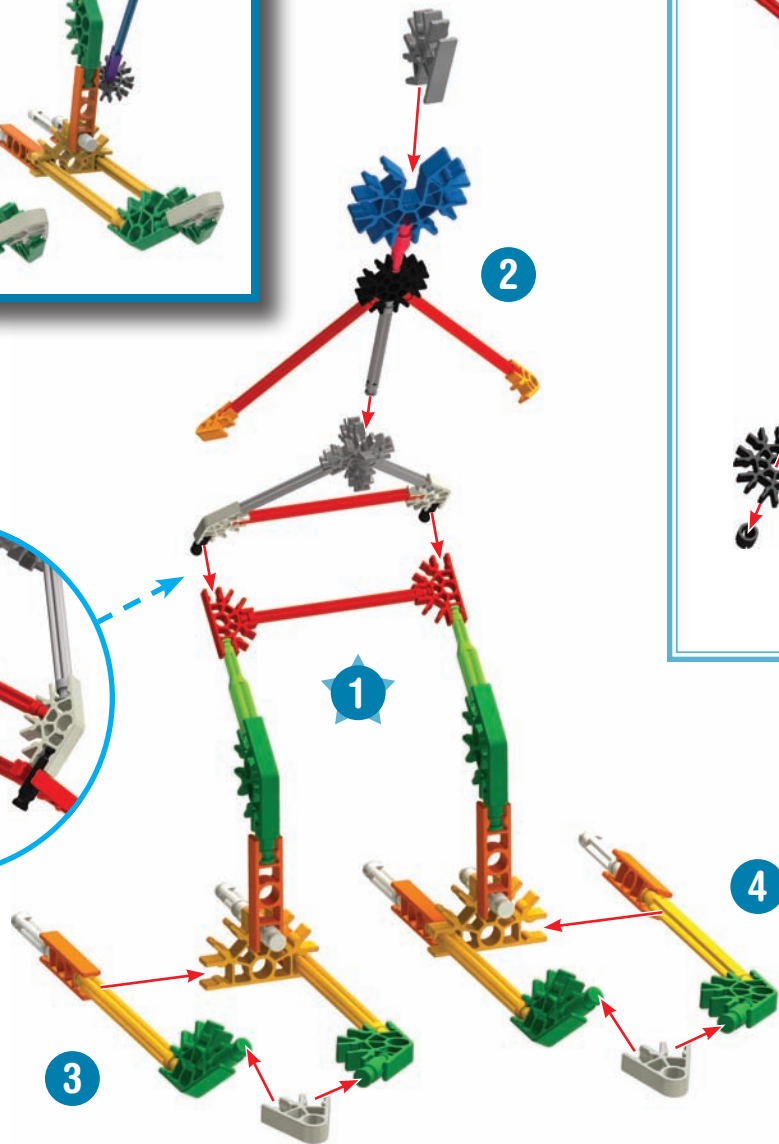

Rocket Ship Fusée

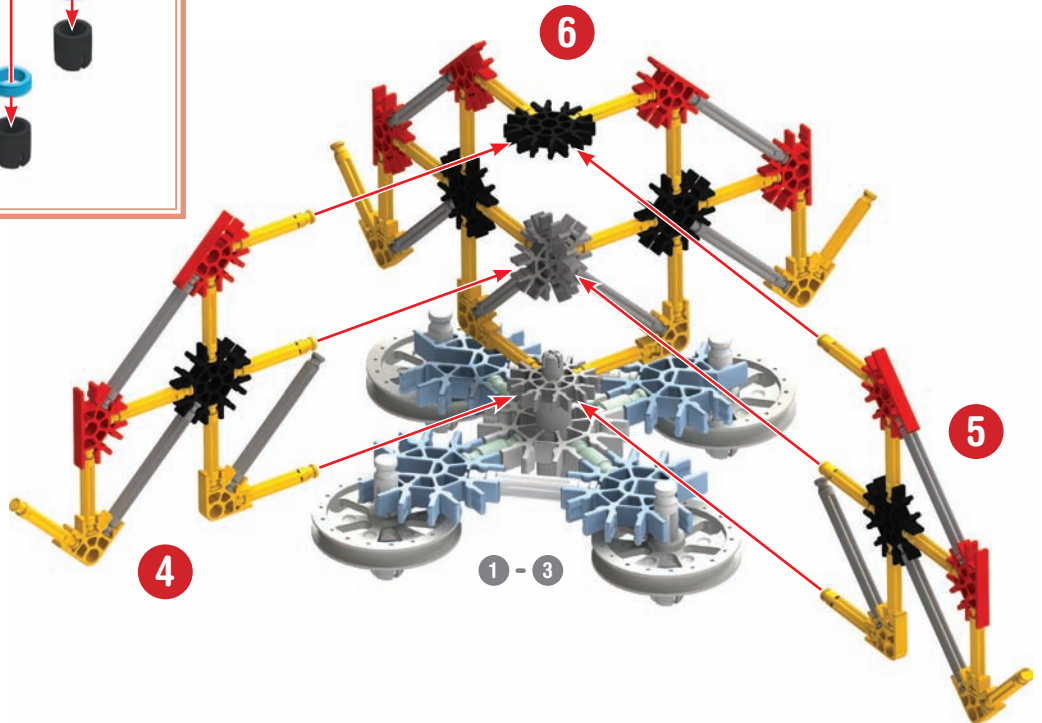
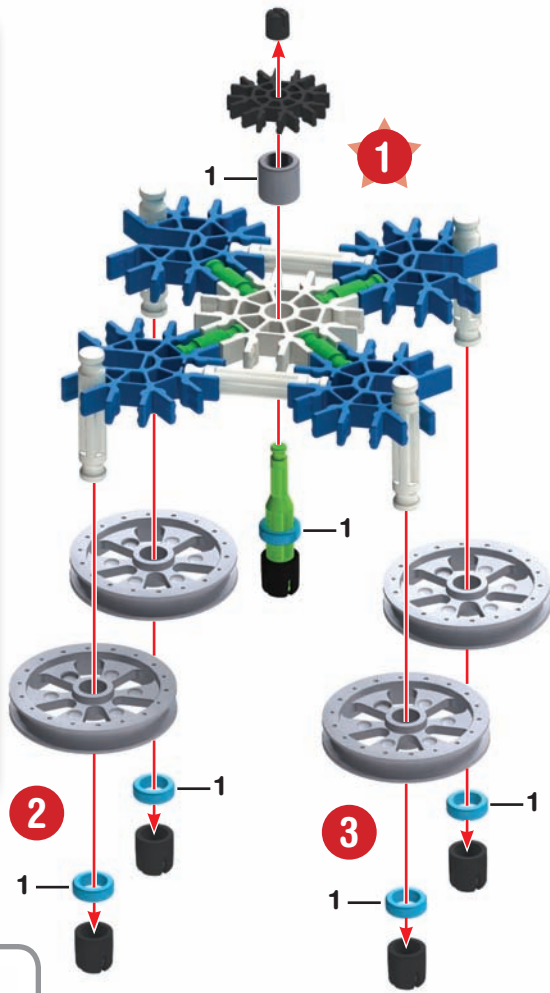

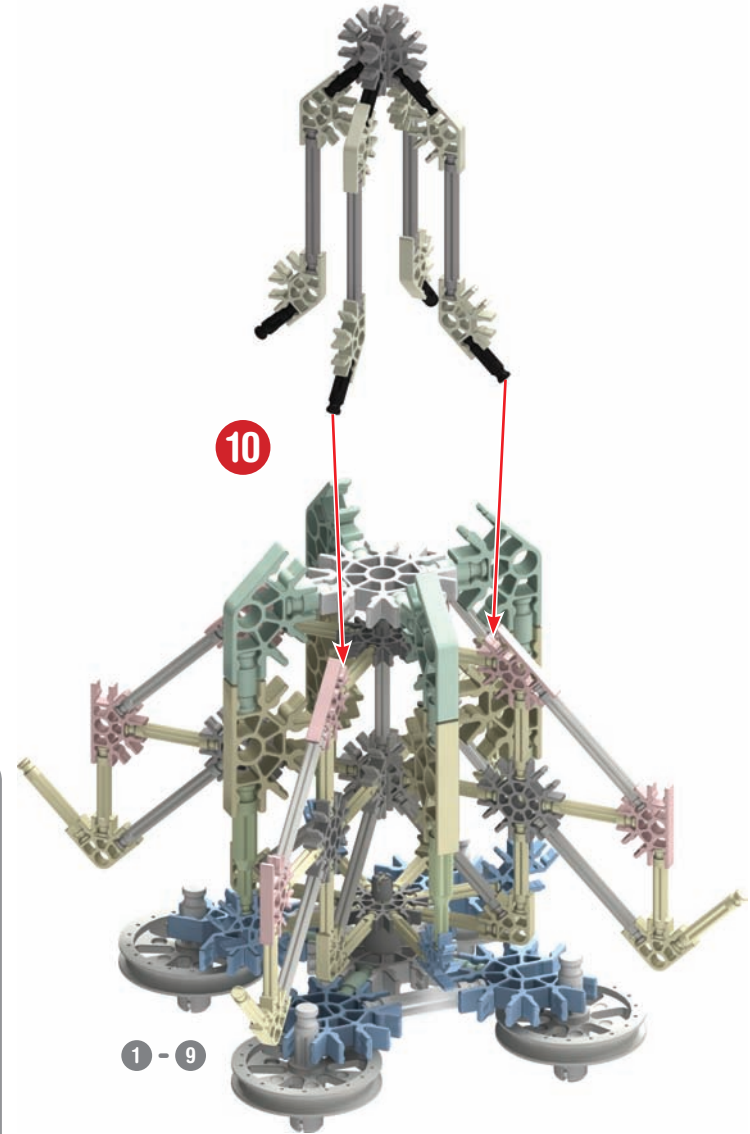
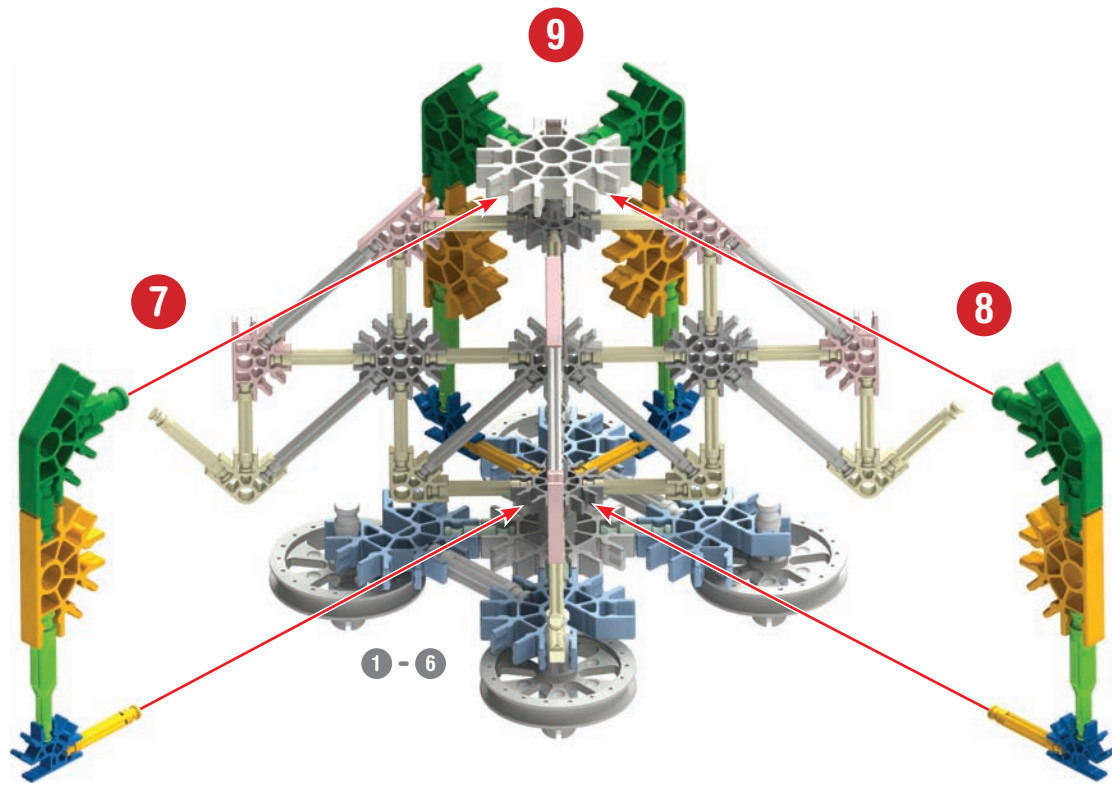

Tyrannosaurus Tyrannosaurus

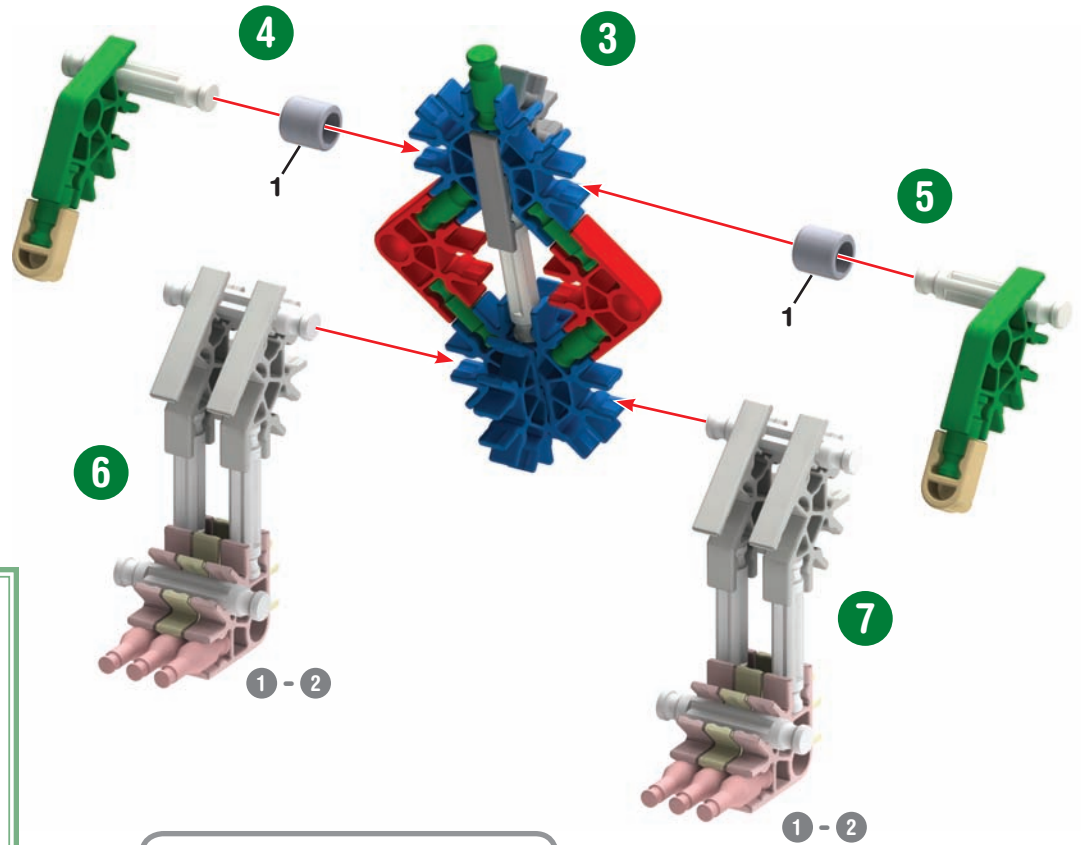

x2

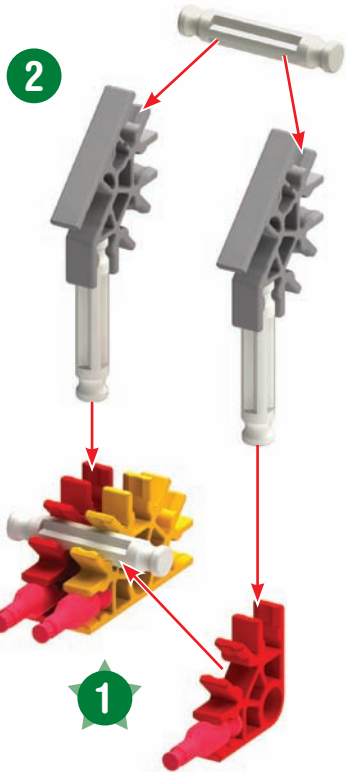

x2



1 - 2

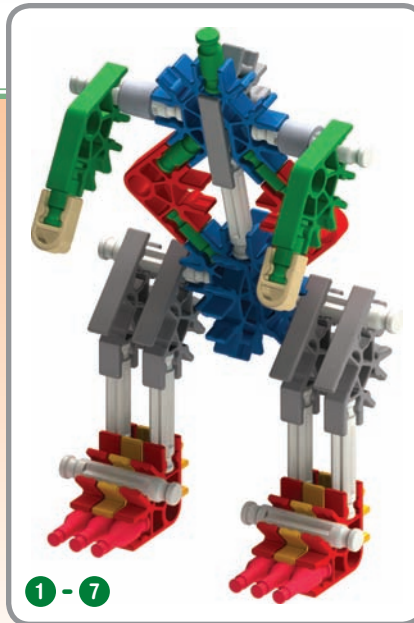

1 - 7

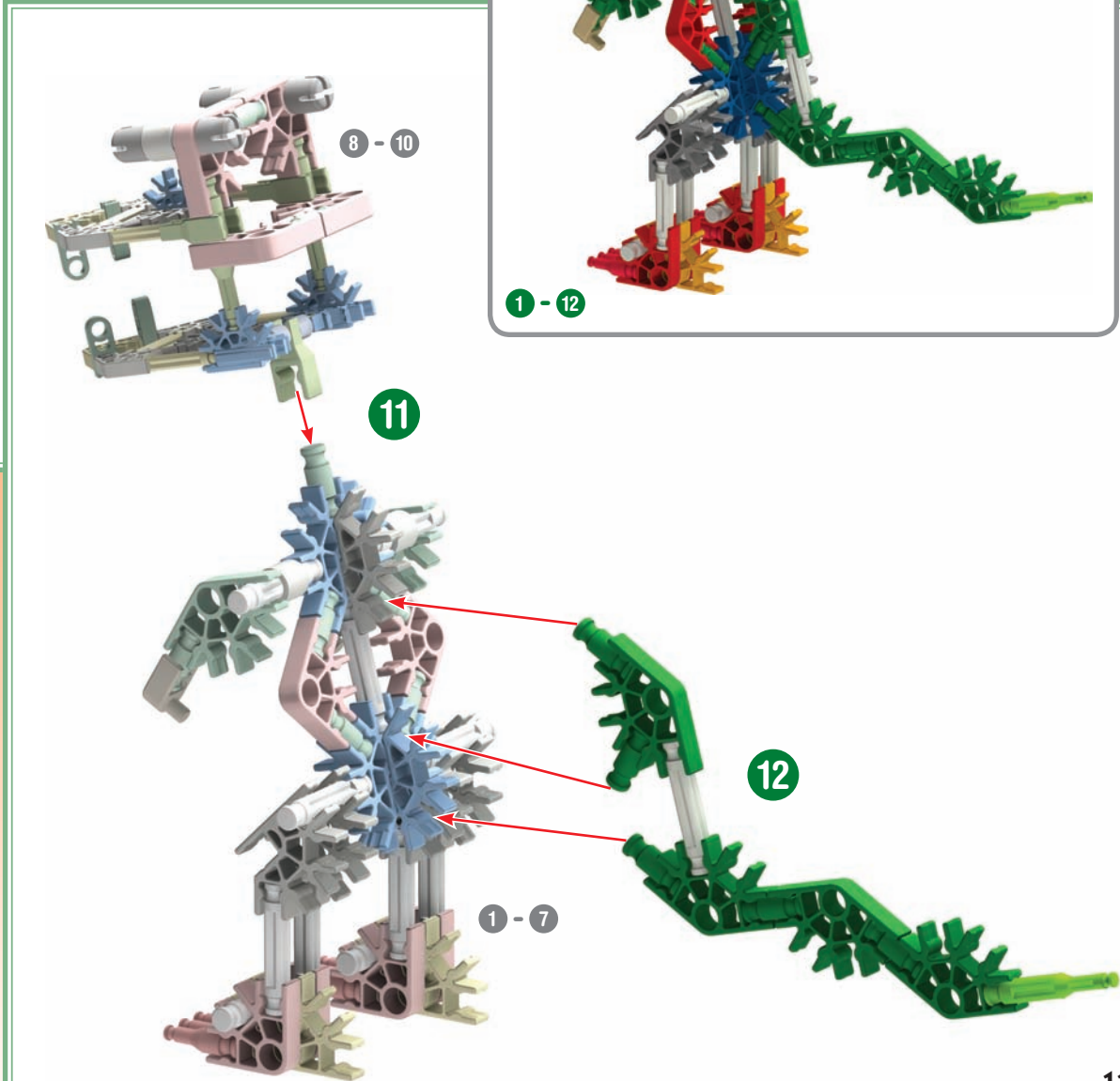
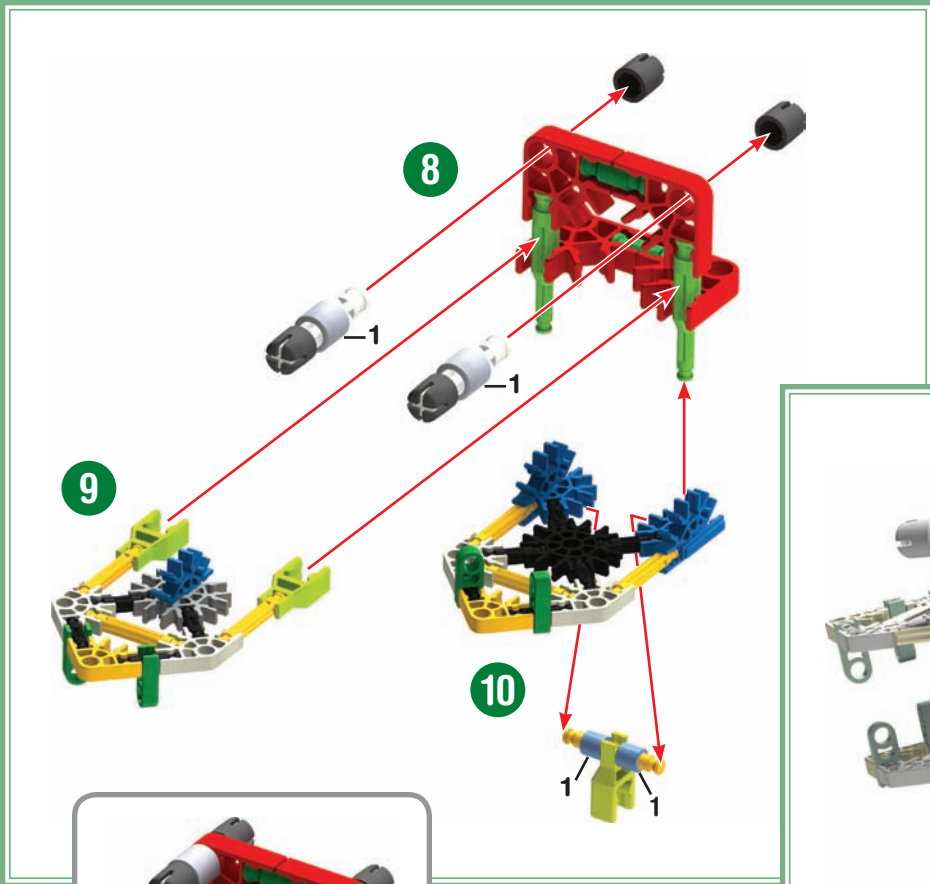

Ferris Wheel Grande Roue

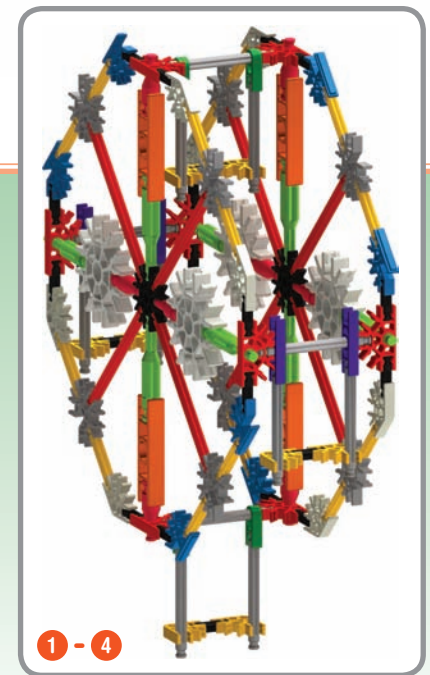
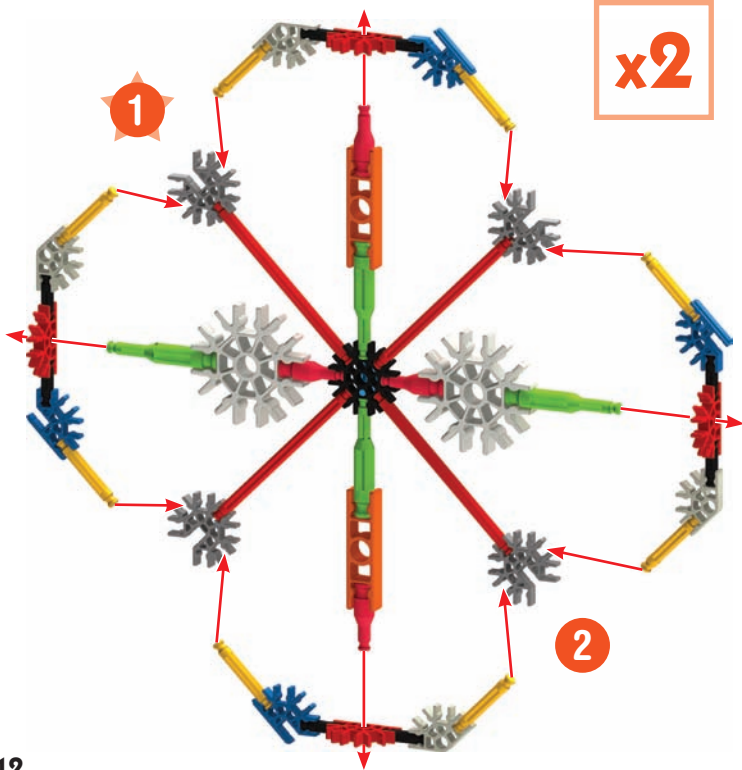
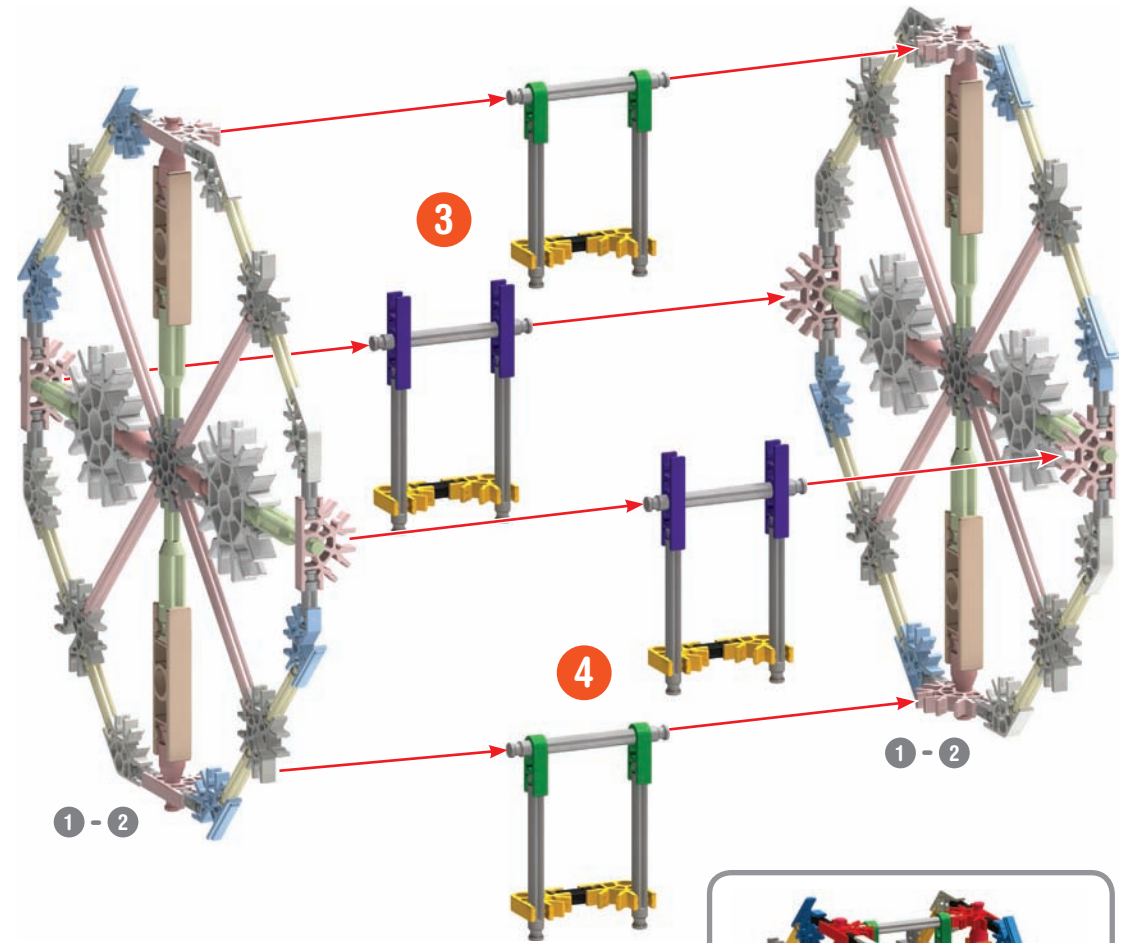
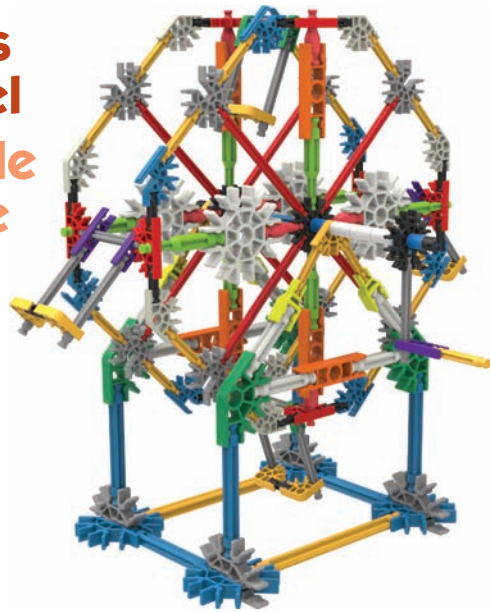

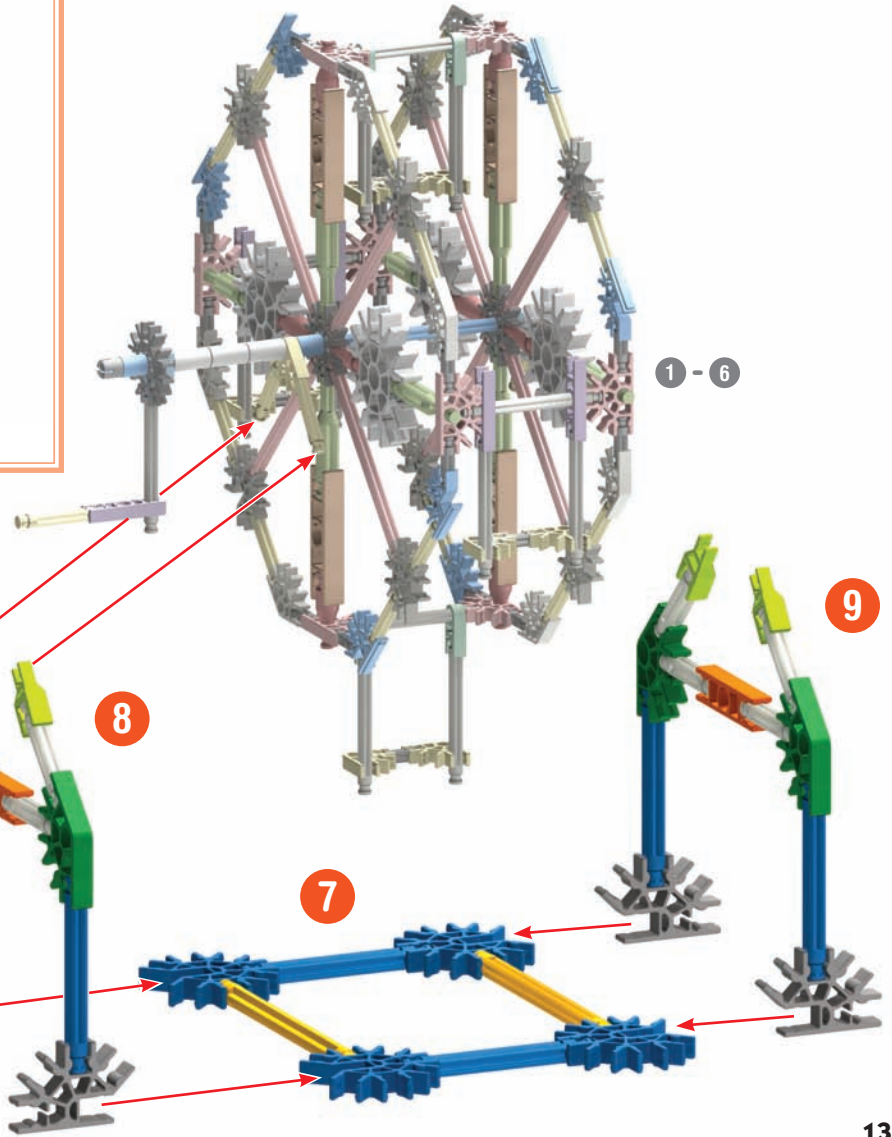
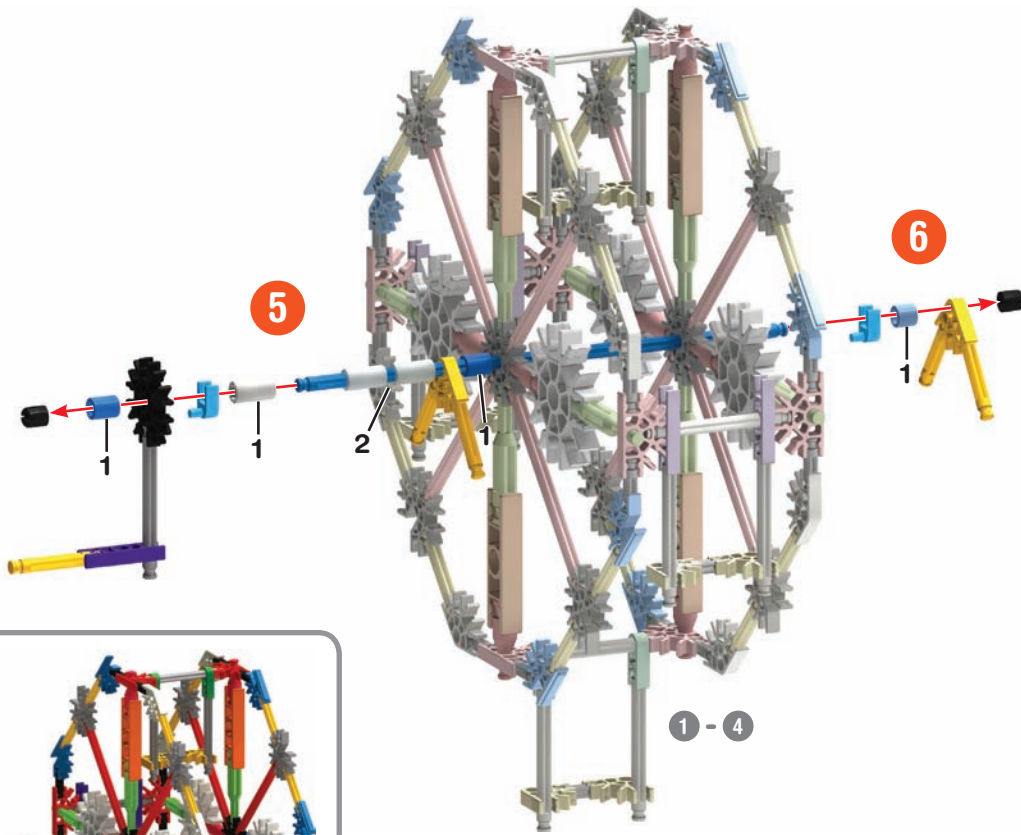

Catamaran Catamaran

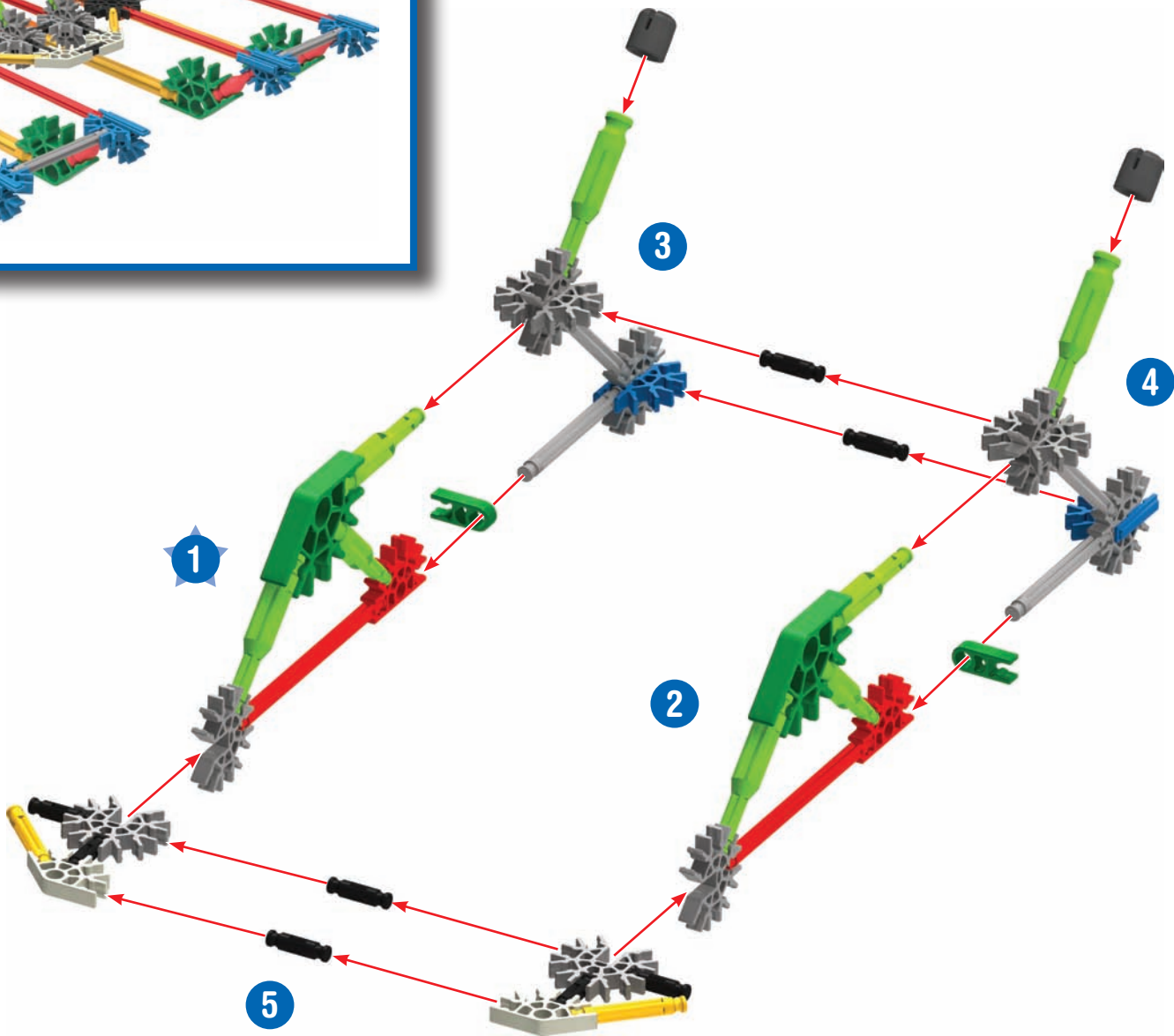
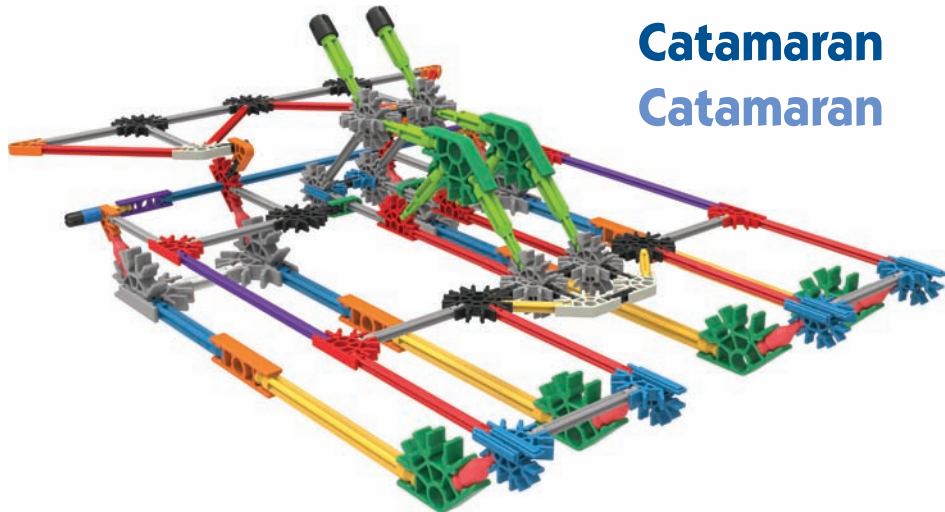

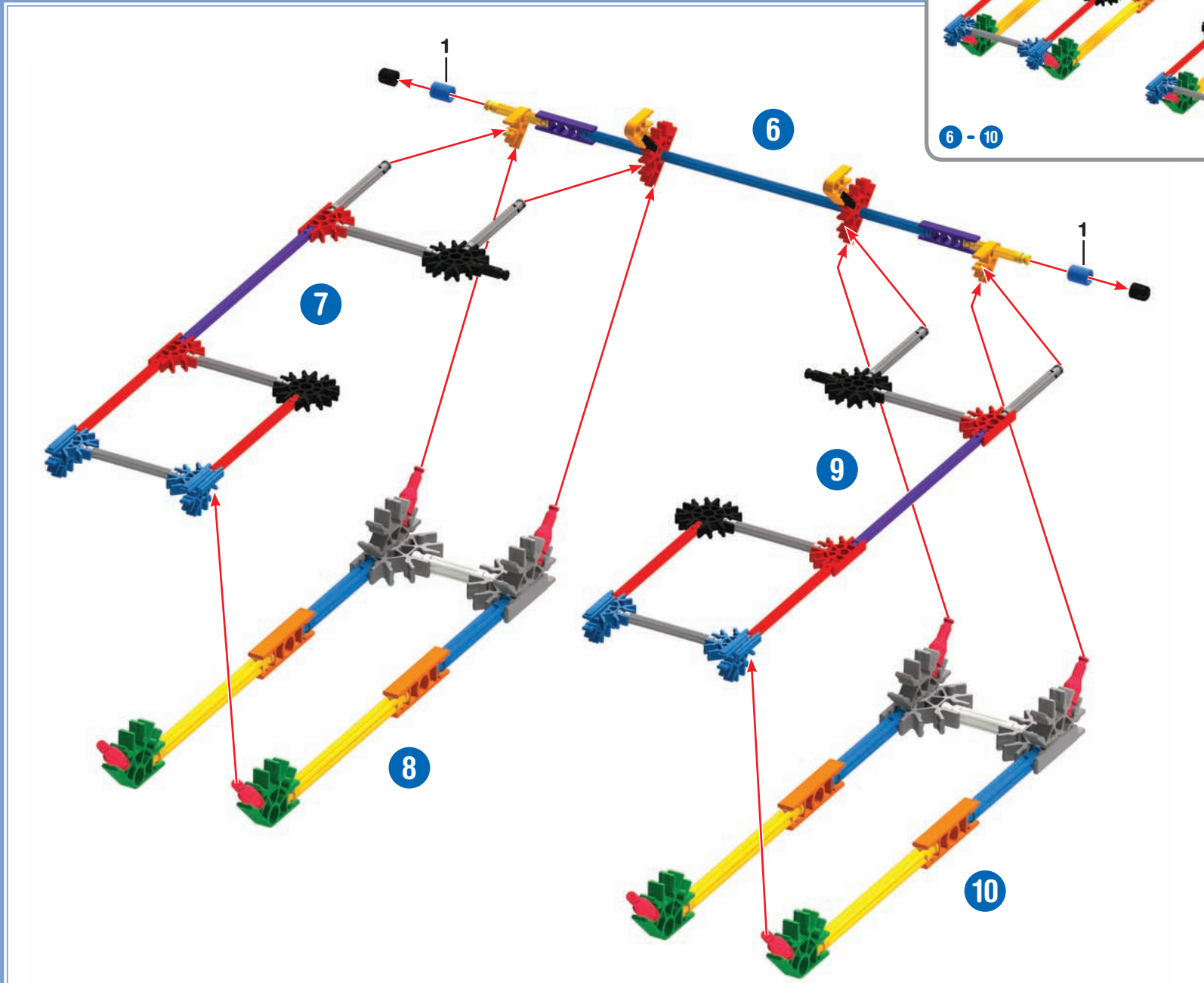

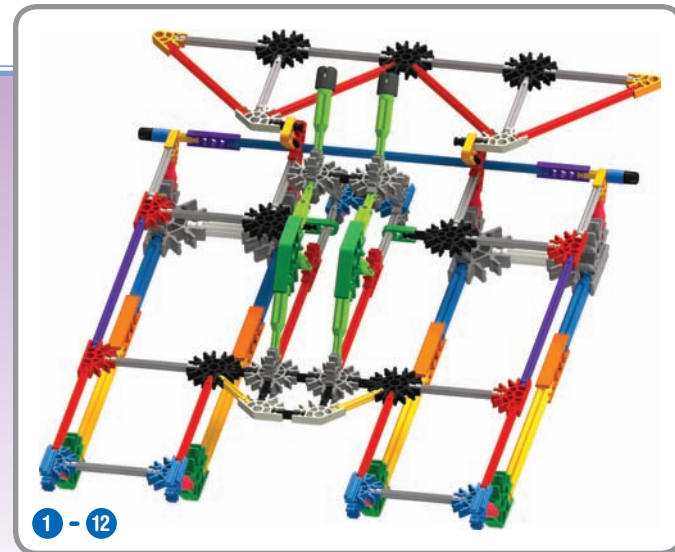
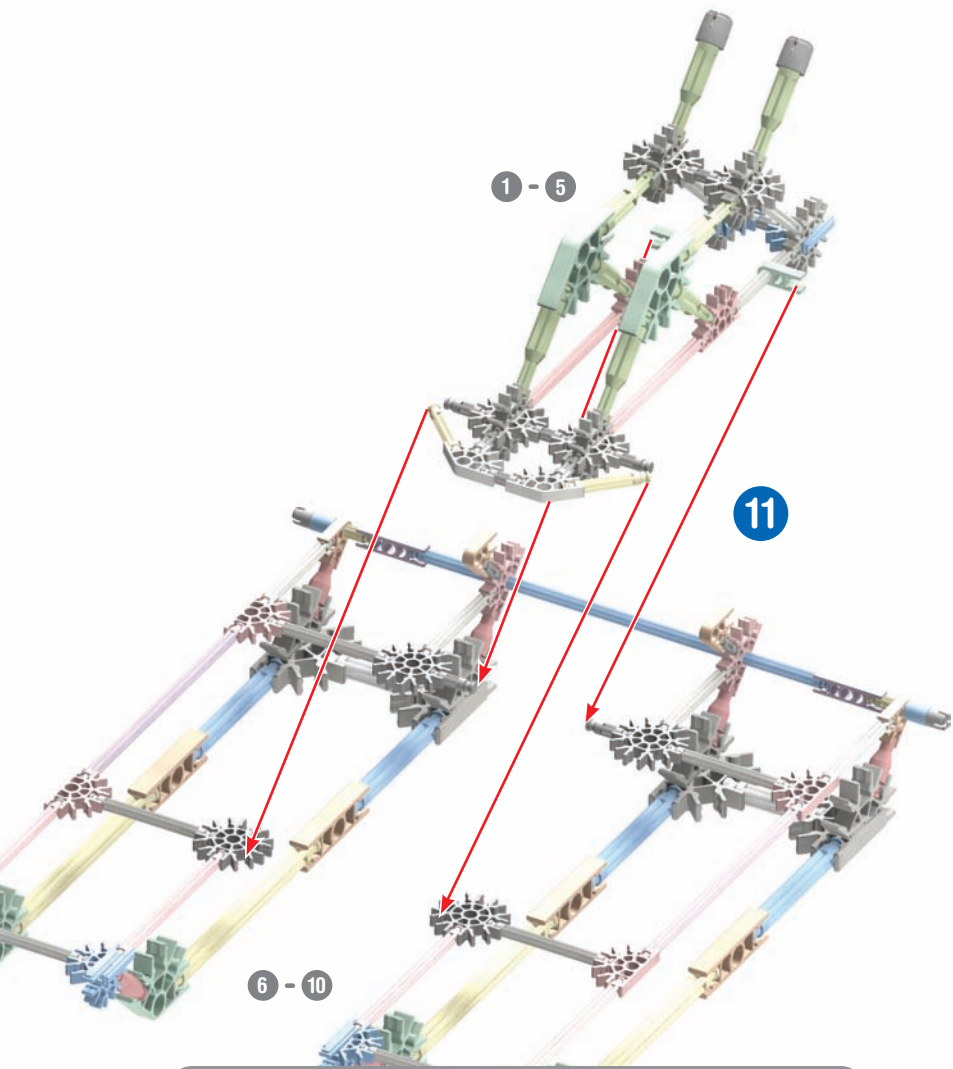

Excavator Pelle

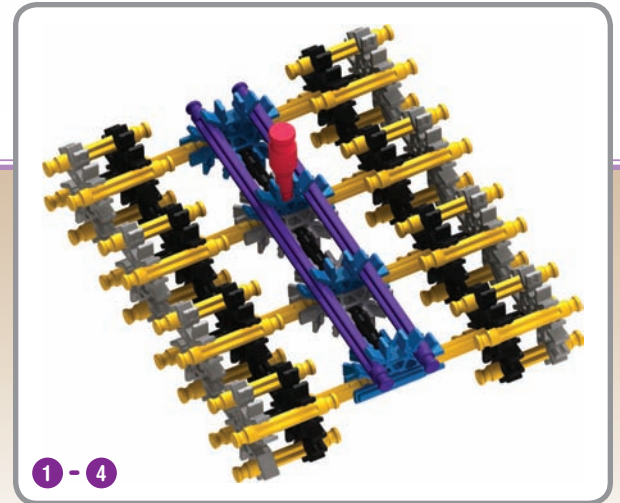
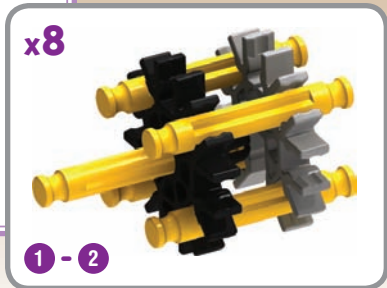
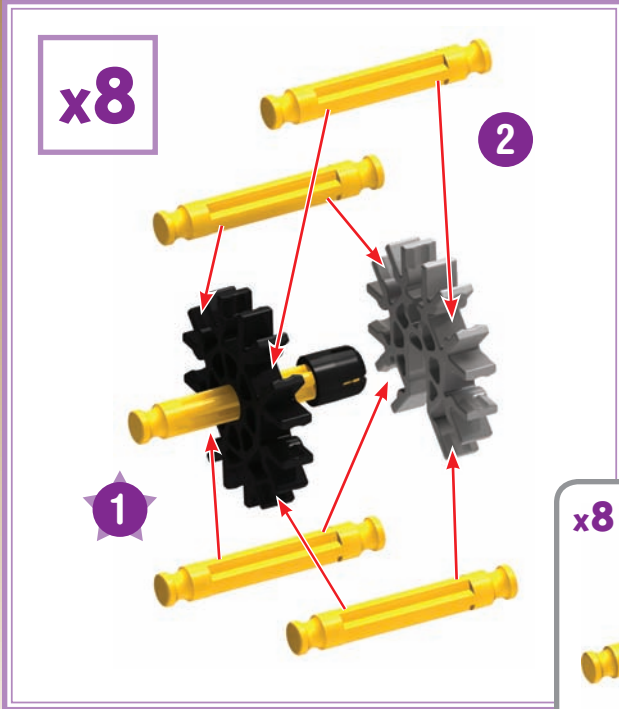
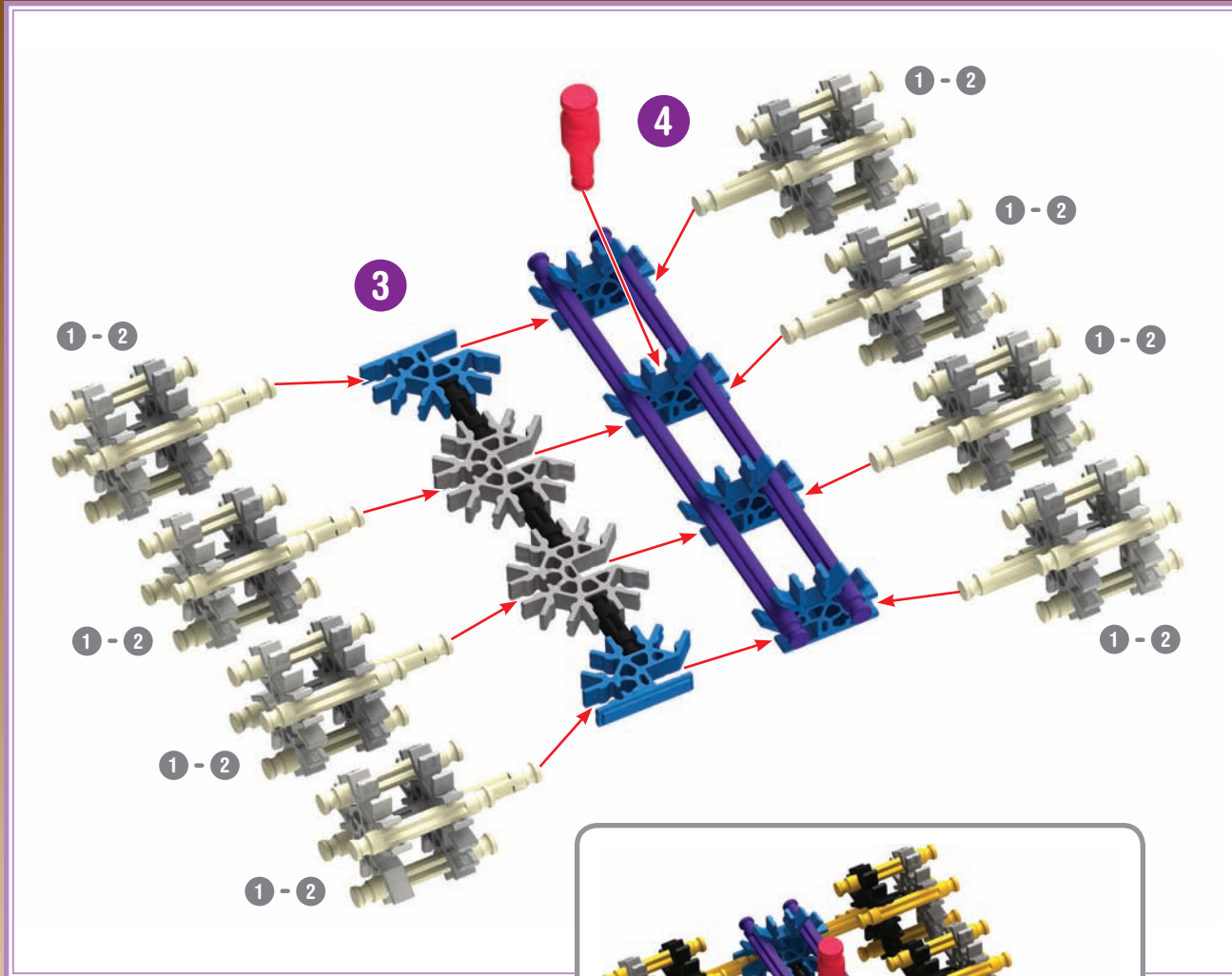

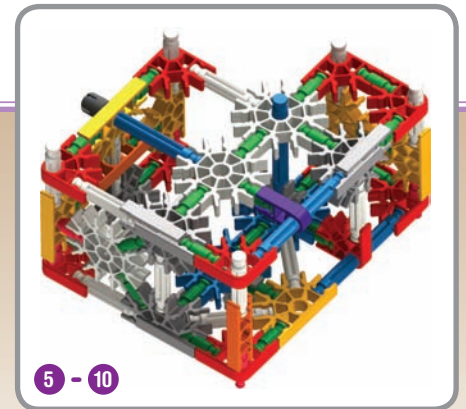
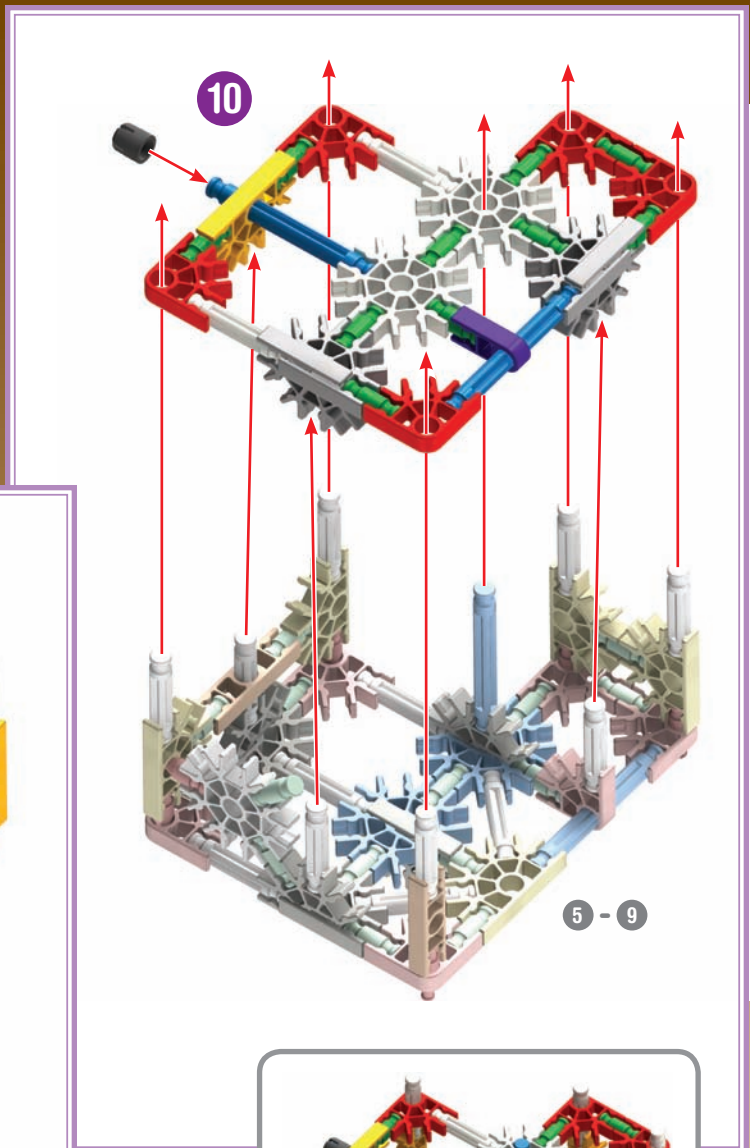
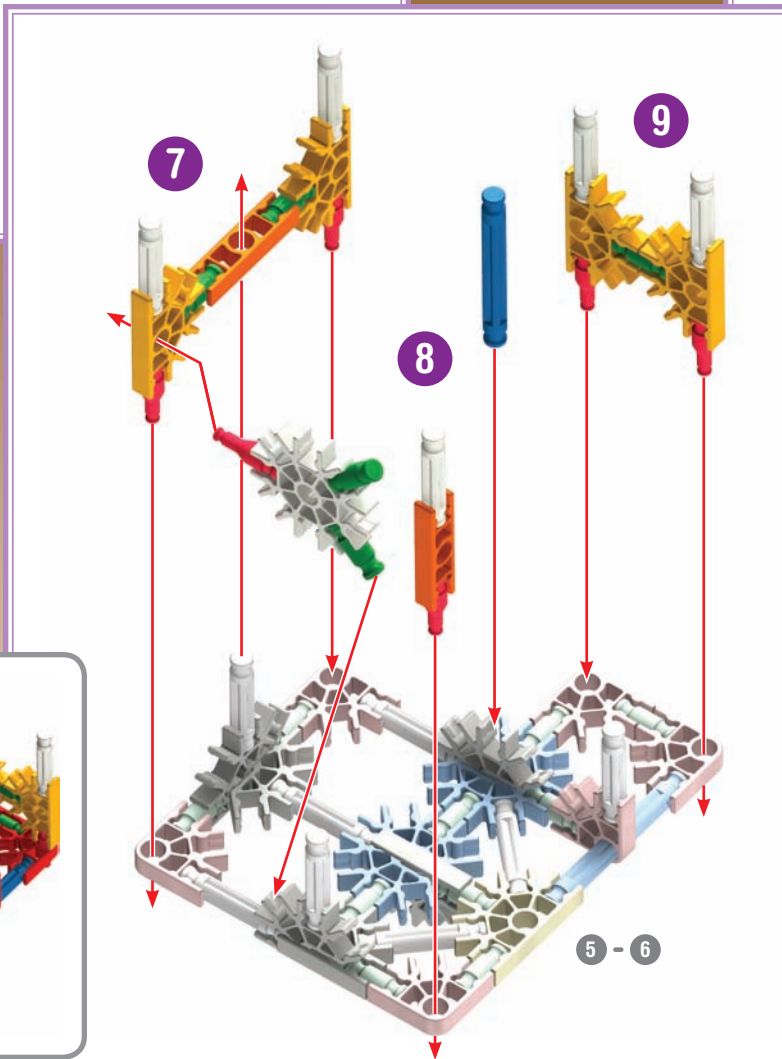
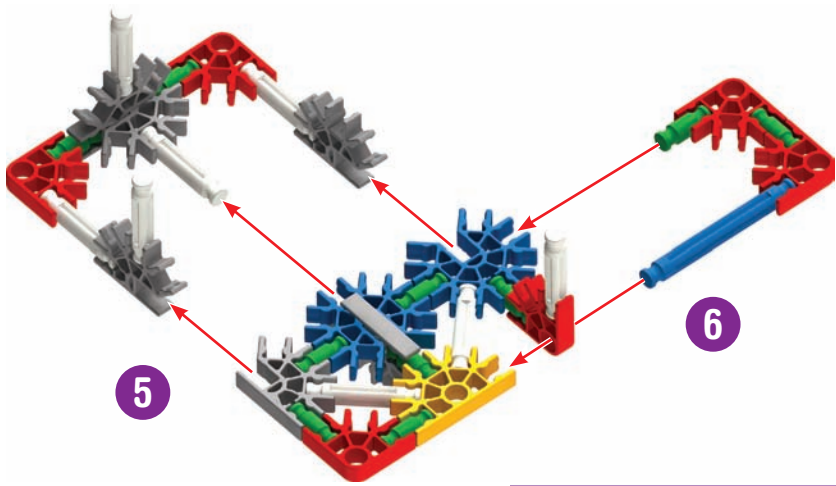

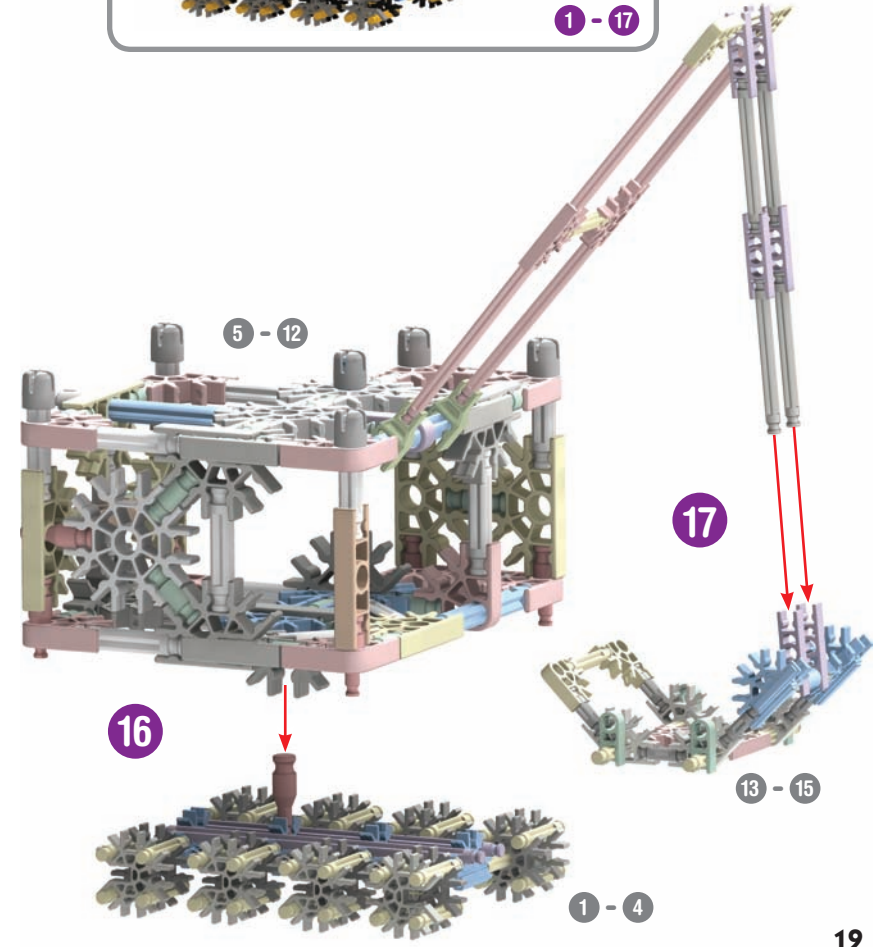
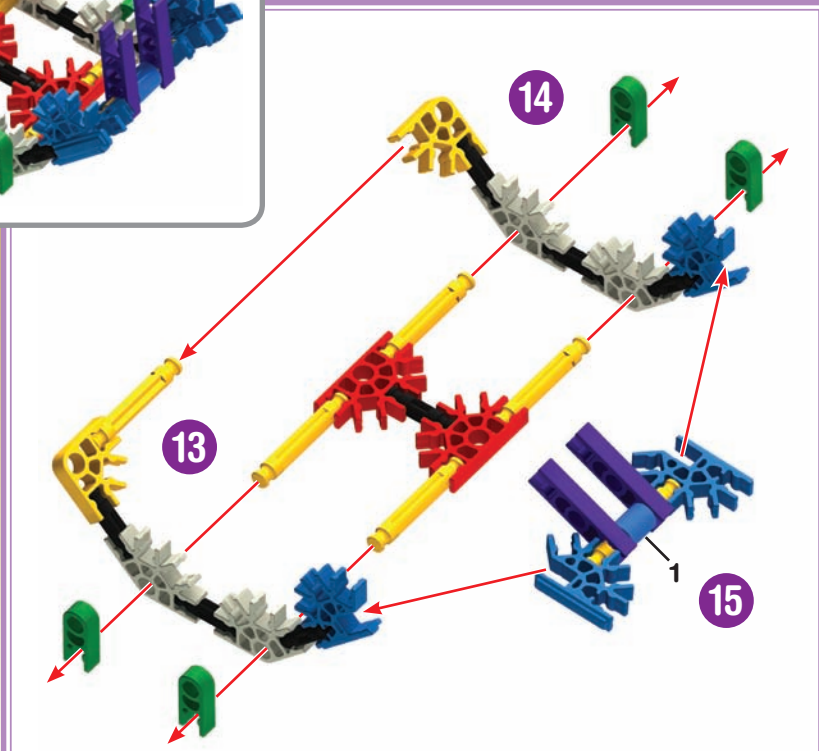
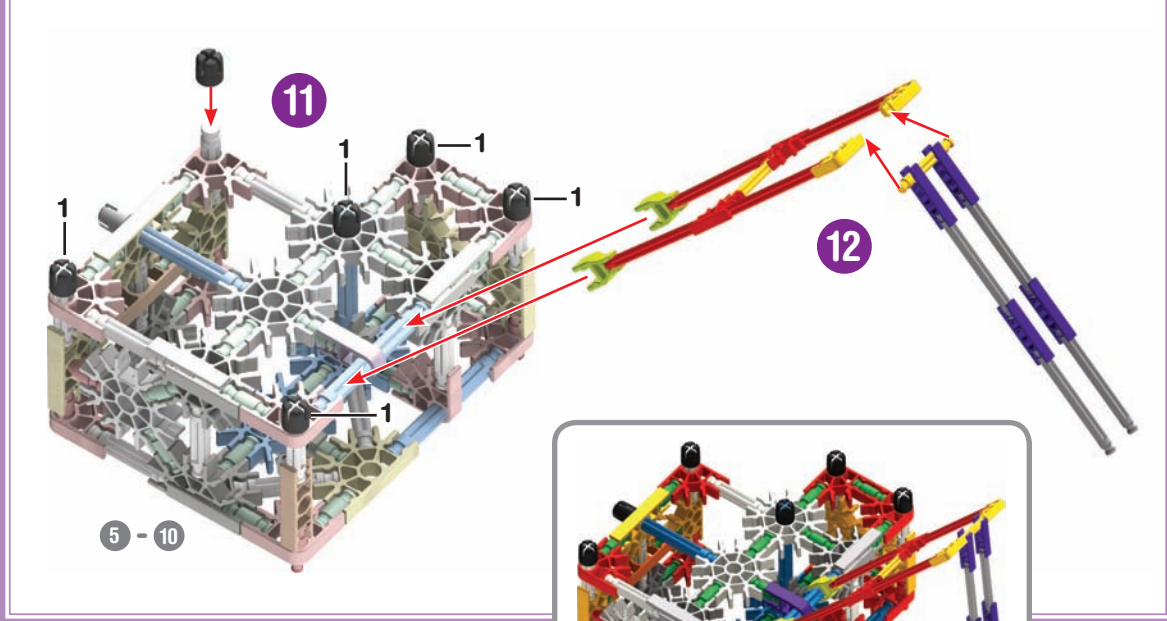

BUILDING IDEAS

For instructions of these models go to www.knex.com/instructions and enter code **12418**

IDÉES DE CONSTRUCTION

Car les instructions de ces modèles vont à www.knex.com/instructions et entrez dans le code **12418**





(ES) Español

(Página 2)

Lista de piezas

Antes de comenzar a construir, compare las piezas de su juego con las que se enumeran aquí. Si falta algo, llámenos o escribanos utilizando la información que se encuentra en el reverso. ¡Estamos aquí para ayudarle!

Esenciales de construcción K'NEX

Para comenzar a construir

Para comenzar el modelo, encuentre el número 1 del paso y siga los números. Cada pieza tiene su propia forma y color. Observe las imágenes, encuentre las piezas que sean iguales a las que se muestran y conéctelas. Colocar el modelo en la misma dirección que se encuentra en las instrucciones le facilitará la construcción. Las flechas muestran en dónde se conectan las piezas, pero no todos los puntos de conexión tienen flechas. Las partes de color tenue son las que ya armó.

Separadores

Hay sitios en el modelo en los que necesita utilizar separadores. Asegúrese de usar el número correcto de separadores que se muestra en las instrucciones.

Conectores

Puede unir estos conectores especiales deslizándolos Presione con fuerza hasta que oiga un "clic". Preste especial atención a las instrucciones y colóquelos de forma horizontal o vertical, exactamente como se muestra.

(DE) Deutsch

(Seite 2)

Teileliste

Bevor du mit dem Bauen anfängst, solltest du prüfen ob die Teile in deinem Bausatz mit denen auf dieser Teileliste übereinstimmen. Falls etwas fehlt, rufe uns an oder schreibe uns (siehe Rückseite). Wir sind für dich da!

Grundlegende Bauanleitungen für K'NEX

Los geht's mit dem Bauen

Um mit dem Bauen deines Modells zu beginnen, suche die Nummer 1 und folge den laufenden Nummern. Jedes Teil hat seine eigene Form und Farbe. Schau dir einfach die Abbildungen an,

such die Teile in deinem Bausatz, die so aussehen wie das, was du auf der Abbildung siehst und steck sie ineinander. Versuche, dein Modell beim Zusammenbauen so zu orientieren, dass es in die gleiche Richtung weist, wie es in den Anleitungen beschrieben und gezeigt wird. Blasser Farben weisen darauf hin, dass dieser Streckenabschnitt bereits zusammengebaut ist.

Abstandsstücke

An manchen Stellen in deinem Modell musst du Abstandsstücke einbauen. Achte darauf, die richtige Farbe und Anzahl von Abstandsstücken wie in der Anleitung gezeigt zu verwenden.

Verbindungsstücke

Blaue und silberfarbene verbindungsstücke haben besonders lange Schlitze. Wie du auf der Abbildung sehen kannst, lassen sie sich ineinander schieben. Achte beim Aneinanderfügen dieser Teile darauf, dass du ein Klickgeräusch hörst. Erst dann sind die Teile fest miteinander verbunden.

(IT) Italiano

(Pagina 2)

Elenco delle parti

Prima di cominciare a costruire, accertati di confrontare le parti che sono nel tuo set con l'elenco delle parti qui. Se ne manca una chiamaci o scrivici usando le informazioni che sono nella retrocopertina. Noi siamo qui per aiutarvi!

Istruzioni di base per costruire con K'NEX

Comincia a costruire

Per iniziare il modello, cerca il numero 1 e segui i numeri. Ogni pezzo ha una sua forma e un suo colore. Guarda la figura, trova i pezzi corrispondenti nel set e mettili insieme. Cerca di tenere il modello nella stessa direzione della figura e in tal modo sarà più semplice attaccare i pezzi nei posti giusti. I colori spenti ti dicono che questa sezione è già stata costruita. Dovrai collegare la nuova sezione al punto indicato dalla punta della freccia.

Spaziatori

Ci sono punti nel tuo modello a cui dovrai aggiungere spaziatori blu e argento. Accertati di contarli attentamente.

Connettori

È molto importante posizionare i connettori blu e argento in una specifica direzione. Presta molta attenzione alle istruzioni e posiziona i connettori orizzontalmente o verticalmente proprio come illustrato. Spingi con forza fino ad udire un clic.

(PT) Português

(Página 2)

Lista das peças

Antes de começar a montar, compare as partes do seu conjunto com as partes enumeradas aqui. Se houver algo que estiver faltando, ligue ou escreva para nós usando as informações na capa de trás. Estamos aqui para servir e ajudar

Instruções básicas para montar o K'NEX

Comece a montar

Para começar a montar o modelo, encontre o número do passo e siga os números. Cada peça tem a sua própria forma e cor. Estude as ilustrações, encontre as peças que coincidem com o que você estiver vendo e conecte-as. Fique de frente para o modelo, na mesma direção que as figuras mostradas nas instruções. As setas mostram onde as peças se conectam, mas nem todos os pontos de conexão têm setas. As partes com cores desbotadas são as que você já montou.

Separadores

Há lugares no modelo onde você precisará usar separadores. Use o número de espaçadores corretos exibidos nas instruções.

Conectores

Você pode fazer com que estes conectores se deslizem e se conectem. Empurre até ouvir um "clique". Preste atenção às instruções e posicione-os horizontal ou verticalmente exatamente conforme a ilustração.

(NL) Nederlands

(Bladzijde 2)

Onderdelen Lijst

Voordat u begint met bouwen, moet u de onderdelen vergelijken de set met de onderdelen lijst hier. Als er iets ontbreekt, bel of schrijf ons gebruik van de informatie op de achterkant. We zijn hier om u te helpen!

Basisstappen voor K'NEX bouwen

Begin te bouwen

Om met je model te beginnen, vind eerst het nummer 1 en volg de nummers. Elk stuk heeft zijn eigen vorm en kleur. Kijk gewoonweg naar de afbeeldingen, vind de overeenstemmende stukken terug in je geheel en maak e aan mekaar vast. Tracht je model in dezelfde richting te plaatsen als de aanwijzingen terwijl je bouwt en monteert. De vervaagde kleuren duiden aan dat dit deel reeds is opgebouwd. Gelieve het nieuwe deel vast te koppelen op de plaats aangeduid door de pijlen.

Tussenstukken

In je model zijn er plaatsen waar blauwe en zilveren tussenstukken moeten toegevoegd worden. Verzeker je ervan de juiste kleur te gebruiken en tel ze zorgvuldig.

Koppelstukken

Er zijn blauwe en zilveren koppelstukken met speciale lange gleuven. Ze schuiven in mekaar zoals je kunt zien op de afbeeldingen. Duw deze onderdelen in mekaar tot je een "klik" hoort.

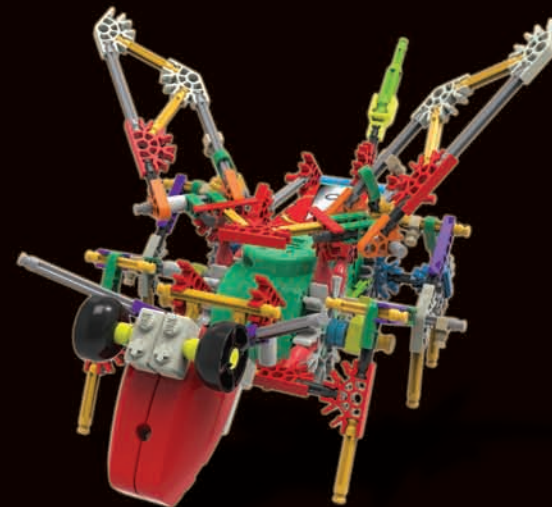

**ROBO-SMASH™
BUILDING SET
JEU DE
CONSTRUCTION**



**ROBO-STRIKE™
BUILDING SET
JEU DE
CONSTRUCTION**



**ROBO-STING™
BUILDING SET
JEU DE
CONSTRUCTION**

(EN) K'NEX, Building Worlds Kids Love and America's Building Toy are registered trademarks of K'NEX Limited Partnership Group.
(FR) K'NEX, Building Worlds Kids Love et America's Building Toy sont des marques déposées de K'NEX Limited Partnership Group.
(ES) K'NEX, Building Worlds Kids Love y America's Building Toy son marcas registradas de K'NEX Limited Partnership Group.

(EN) Product & colors may vary. Most models can be built one at a time.
(FR) Produits et couleurs peuvent varier. La plupart des modèles ne peuvent être construits que un à un.
(ES) El producto y los colores pueden variar. La mayoría de los modelos se pueden construir uno a la vez.
(DE) Produkte und Farben können variieren. Meisten Modelle können nur jeweils einzeln gebaut werden.
(IT) Prodotti e colori possono differire. La maggior parte dei modelli si può costruire autonomamente. Istruzioni accluse.
(PT) O produto e as cores podem variar. A maioria dos modelos pode ser montado um de cada vez.
(NL) Product en kleuren kunnen variëren. De meeste modellen kunnen een voor een worden gebouwd.

** Sold separately. Some products may not be available in all markets.

Vendus séparément. Certains produits ne sont pas disponibles pour tous les marchés.

Se venden por separado. Algunos productos no pueden estar disponibles en todos los mercados.

Separat verkauft. Einige Produkte können möglicherweise nicht in allen Märkten vorhanden sein.

Venduto esclusivamente. Alcuni prodotti non possono essere disponibili in tutti i mercati.

Vendido separada. Alguns produtos não podem estar disponíveis em todos os mercados.

Afzonderlijk verkocht. Sommige producten kunnen niet in alle markten beschikbaar zijn.



©2014 K'NEX Limited Partnership Group
P.O. Box 700
Hatfield, PA
19440-0700

112418-V1-1/14